

# DVG-2001s Setup (FW-V5)

Connect your DVG-2001s as per your quick installation guide.

The diagram below indicates the connections on the rear of the device.

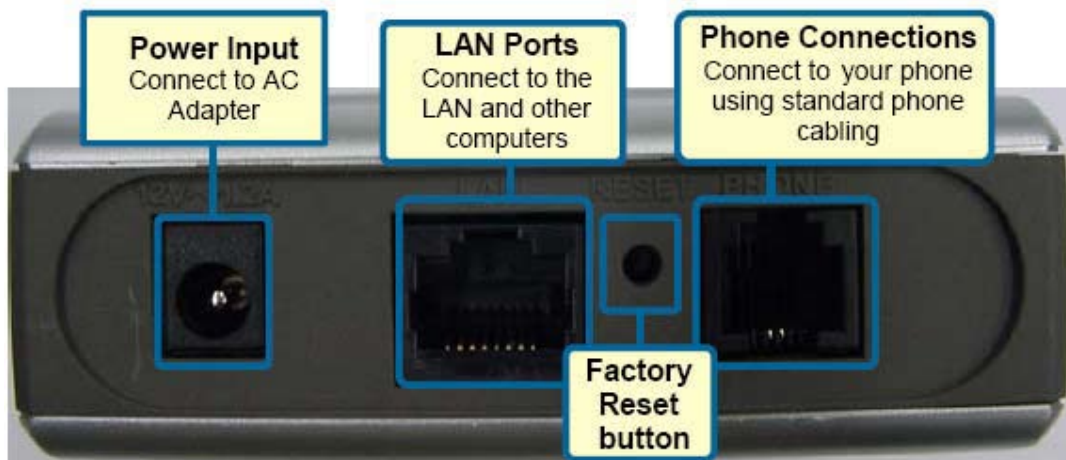

Once connected and powered up, lift the handset of your telephone and type “\*\*1” on the keypad.

The device will read the IP address it has been allocated by your ADSL router.

For example in this case: 10.1.1.5

Open an Internet Explorer Browser and type your allocated IP address into the address line of your browser as per below



To log in, type admin/admin then click OK

The login dialog box appears:

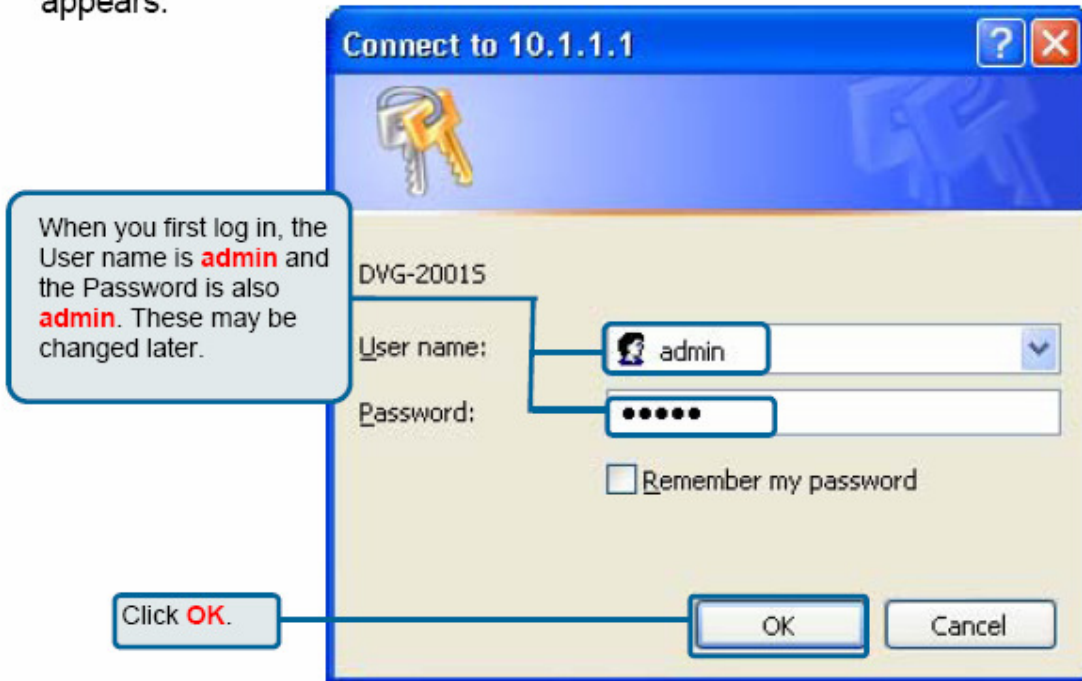

The default log in screen will appear

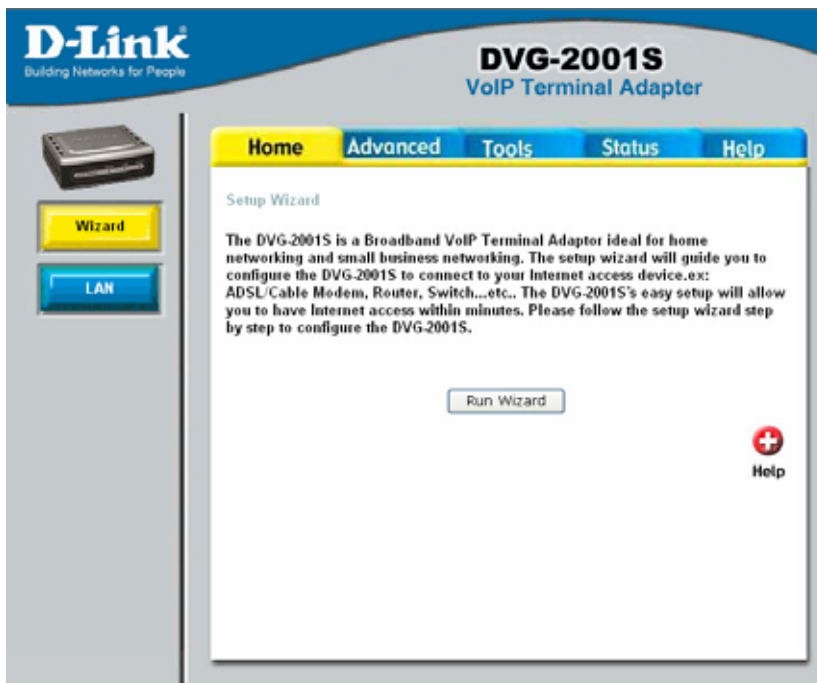

Select "Advanced" from the horizontal tabs.

Set up the server configuration section as per the below settings.

The proceed further down this screen shows how to set up the codec order.

**Home** **Advanced** **Tools** **Status** **Help**

**SIP Configuration:**  
 Server Configuration  Provisioning  STUN Configuration  User Agent  Peer to Peer  Telephony

**SIP Configuration-Server**

Server FQDN: enabled

IP Address: . . .

Domain Name: sip.gotalk.com

Port: 5060

Outbound Proxy State: disabled

Outbound Proxy Sever FQDN: disabled

Outbound Proxy IP Address: . . .

Outbound Proxy Domain Name:

Outbound Proxy Port: 0

Service Domain: sip.gotalk.com

URL Format: SIP-URL

User Parameter Phone: enabled

Caller ID Delivery: YES

Display CID: enabled

Timer T2: 4 sec

Initial Unregister: enabled

Register Expiration: 240 sec

Session Expires: 180 sec

Min-SE: 180 sec

Session Expires Refresher: uac

Further down the same screen, set the codec order as per the image below  
Select "Apply" to lock in these settings.

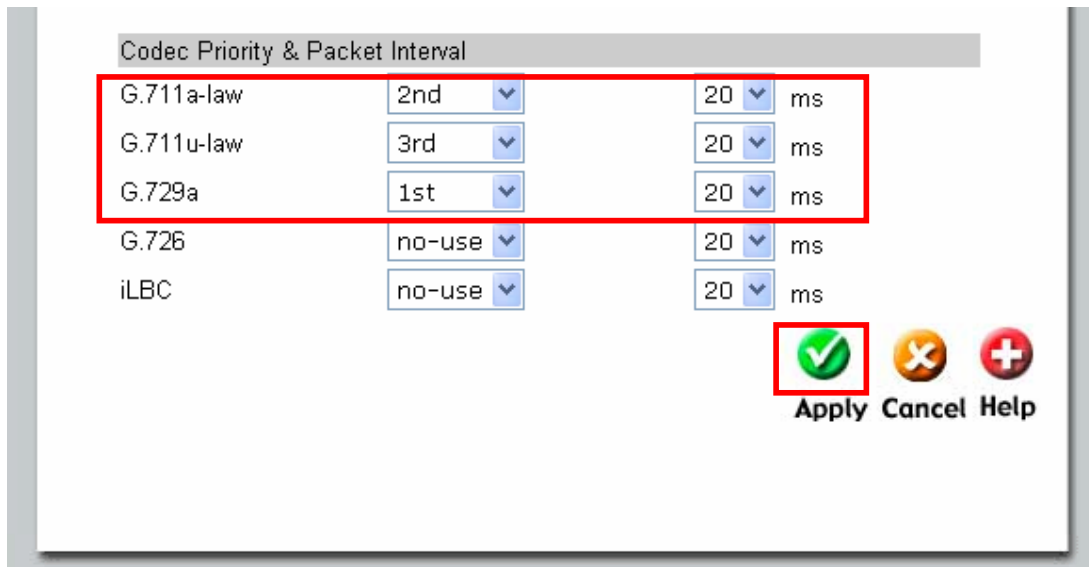

Then click on "OK" on the following message.

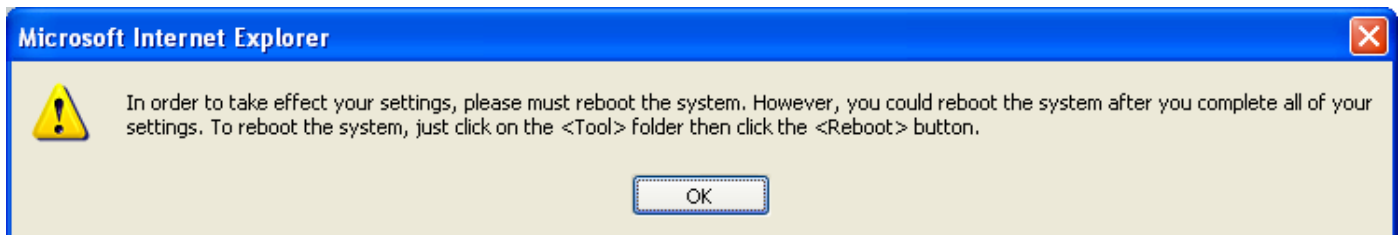

On the same TAB select "User Agent"

Enter your gotalk username and password details, then select "Apply"

**D-Link**  
Building Networks for People

**DVG-2001S**  
VoIP Terminal Adapter

Home **Advanced** Tools Status Help

SIP Configuration:  
 Server Configuration  Provisioning  STUN Configuration  **User Agent**   
Peer to Peer  Telephony

SIP Configuration - User Agent

Phone Number	username
Display Name	username
User Agent Port	5060
Authentication Username	username
Password	.....
Retype Password	.....

Apply Cancel Help

Query Registration State  
Query Register Unregister

Then click on "OK" on the following message.

Microsoft Internet Explorer

In order to take effect your settings, please must reboot the system. However, you could reboot the system after you complete all of your settings. To reboot the system, just click on the <Tool> folder then click the <Reboot> button.

OK

On the same TAB select "Telephony"  
Configure all settings as per the below diagram, then select "Apply"

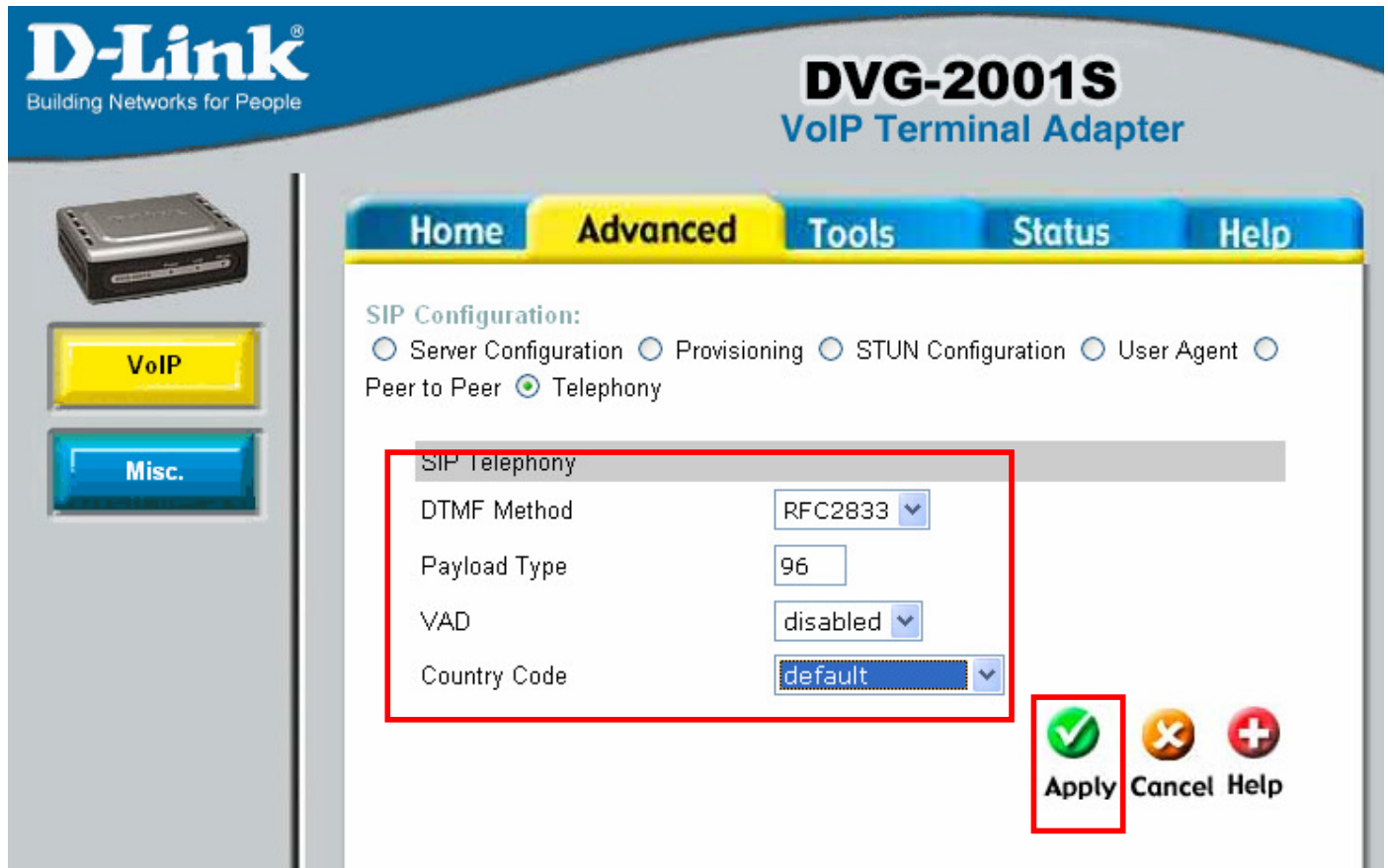

Then click on "OK" on the following message.

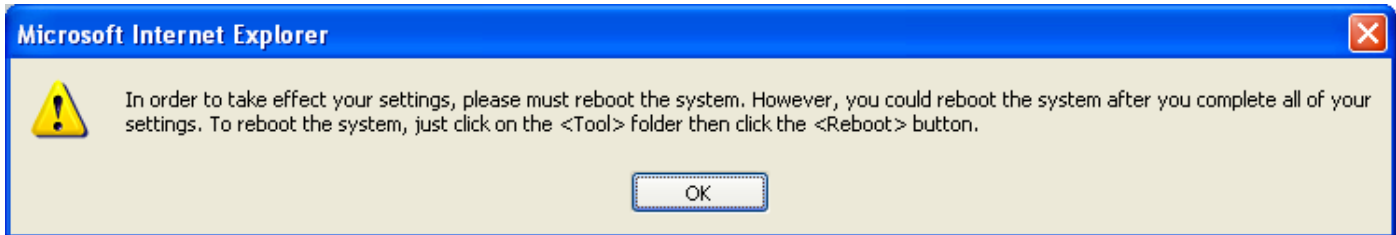

Select the "Tools" tab, and then "Reboot" on the left hand side.

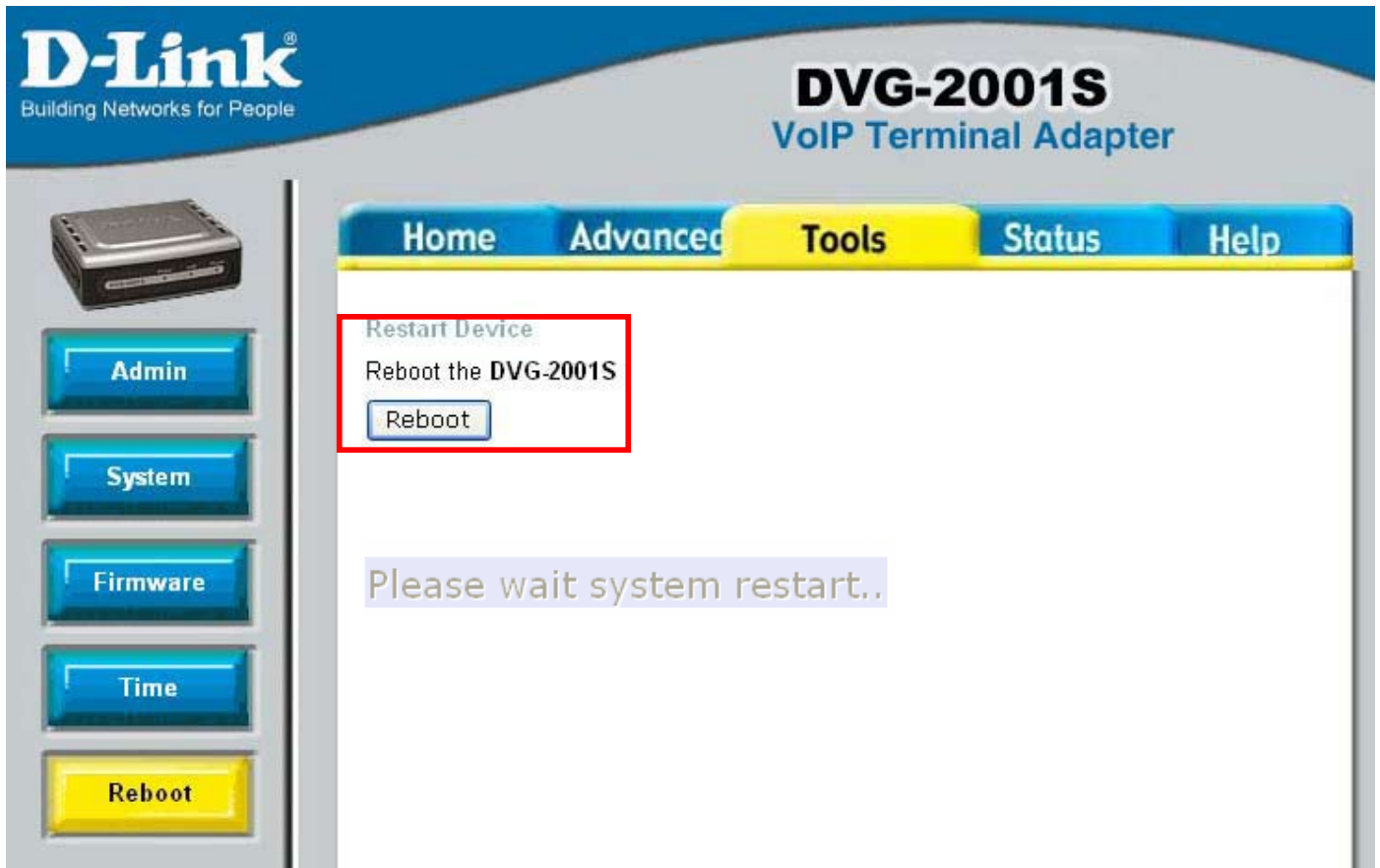

The system will reboot and prompt you with the log in window. At this point there is no need to log in again, as the configuration is set and saved.

If the device has successfully registered, then the telephone connected to it will ring once, indicating that it is online.